

Air-Conditioners for Building Application

INDOOR UNIT

PVFY-P-E00(B) Concealed Vertical Air handler

For Use with CITY MULTI Outdoor Units Only

INSTALLATION MANUAL

For safe and correct use, please read this installation manual thoroughly before installing the air-conditioner.

	Page
1. Inspect Shipment	1
2. Safety Precautions	2
3. Selecting and Installation site	3
4. Installing the unit	4
5. Refrigerant Piping	4
6. Drain Connections	5
7. Electrical wiring	6

INSPECT SHIPMENT

These air handlers are completely factory assembled, and all components are performance tested. Each unit consists of a blower assembly, refrigerant coil and controls in an insulated, galvanized steel factory enclosure. Knockouts are provided for electrical wiring entrance.

1. Check the unit rating plate to confirm specifications are as ordered.
2. Upon receipt of equipment, carefully inspect it for possible damage. Take special care to examine the unit if the carton is damaged.

If damage is found, it should be noted on the carrier's freight bill. Damage claims should be filed with the carrier immediately. Claims of shortages should be filed with the seller within 5 days.

SAFETY PRECAUTIONS

- **Before installation and electric work**

Before installing the unit, make sure you read all the “Safety precautions”.

The “Safety precautions” provide very important points regarding safety. Make sure you follow them.

- **Symbols used in the text**

 **Warning:**

Describes precautions that should be observed to prevent danger of injury or death to the user

 **Caution:**

Describes precautions that should be observed to prevent damage to the unit

 **Warning:**

Carefully read the labels affixed to the main unit.

 **Warning:**

- **The unit must be installed by an authorized Dealer or properly trained technician.**

- Improper installation by the user may result in water leakage, electric shock, or fire.

- **Install the air unit in a place that can withstand its weight.**

- Inadequate strength may cause the unit to fall down, resulting in injuries.

- **Use the specified cables for wiring. Make the connections securely so that the outside force of the cable is not applied to the terminals.**

- Inadequate connection and fastening may generate heat and cause a fire.

- **Prepare for typhoons, hurricanes, earthquakes etc. and install the unit at the specified place.**

- Improper installation may cause the unit to topple and result in injury.

- **Never repair the unit. If the air conditioner must be repaired, consult the dealer.**

- If the unit is repaired improperly, water leakage, electric shock, or fire may result.

- **Do not touch the heat exchanger fins.**

- Improper handling may result in injury.

- **When handling the product, always wear protective equipment.**

- EG: Gloves, full arm protection, and safety glasses.

- Improper handling may result in injury.

- **Install the air conditioner according to this Installation Manual.**

- If the unit is installed improperly, water leakage, electric shock, or fire may result.

- **Have all electric work done by a licensed electrician according the “National Electrical code and local Electrical codes” and “Interior Wire Regulations” and the instructions given in this manual and always use a special circuit.**

- If the power source capacity is inadequate or electric work is performed improperly, electric shock and fire may result.

- **Keep the electric parts away from water (washing water etc.).**

- It might result in electric shock, catching fire or smoke.

- **When cleaning the Heat Exchanger and Drain Pan, ensure the Control Box, Motor and LEV remain dry, using a water proof covering.**

- **When installing and moving the air conditioner to another site, do not charge it with a refrigerant different from the refrigerant specified on the unit.**

- If a different refrigerant or air is mixed with the original refrigerant, the refrigerant cycle may malfunction and the unit may be damaged.

- **When moving and reinstalling the air conditioner, consult the dealer or an authorized technician.**

- If the air conditioner is installed improperly, water leakage, electric shock, or fire may result.

- **Do not reconstruct or change the settings of the protections devices.**

- If the pressure switch, thermal switch, or other protection devices are shorted and operated forcibly, or parts other than those specified by Mitsubishi Electric are used, fire or explosion may result.

- **To dispose of this product, consult your dealer.**

- **Do not use a leak detection additive.**

Precautions for devices that use R410A refrigerant

 **Caution:**

- **Do not use the existing refrigerant piping.**

- The old refrigerant and refrigeration oil in the existing piping contains a large amount of chlorine which may cause the refrigerator oil of the new unit to deteriorate.

- **Use refrigerant piping made of C1220 (Cu-DHP) phosphorus deoxidized copper as specified in the JIS H3300 “Copper and copper alloy seamless pipes and tubes”. In addition, be sure that the inner and outer surfaces of the pipes are clean and free of hazardous sulphur, oxides, dust/dirt, shaving particles, oils, moisture, or any other contaminants.**

- Contaminants on the inside of the refrigerant piping may cause the refrigerant residual oil to deteriorate

- **Store the piping to be used during installation indoors and keep both ends of the piping sealed until just before brazing. (Store elbows and other joints in a plastic bag.)**

- If dust, dirt, or water enters the refrigerant cycle, deterioration of the oil and compressor trouble may result.

- **Use liquid refrigerant to fill the system.**

- If gas refrigerant is used to seal the system, the composition of the refrigerant in the cylinder will change and performance may drop.

- **Do not use a refrigerant other than R410A.**

- If another refrigerant is used, the chlorine in the refrigerant may cause the refrigerator oil to deteriorate.

- **Use a vacuum pump with a reverse flow check valve.**

- The vacuum pump oil may flow back into the refrigerant cycle and cause the refrigerator oil to deteriorate.

- **Do not use the following tools that are used with conventional refrigerants.**

- (Gauge manifold, charge hose, gas leak detector, reverse flow check valve, refrigerant charge base, vacuum gauge, refrigerant recovery equipment).

- If the conventional refrigerant and refrigeration oil are mixed in the R410A, the refrigerant may deteriorate.
- If water is mixed in the R410A, the refrigeration oil may deteriorate.
- Since R410A does not contain any chlorine, gas leak detectors for conventional refrigerant will not react to it.
- **Be especially careful when managing the tools.**
 - If dust, dirt, or water gets in the refrigeration system, the refrigerant may deteriorate.

Before Getting Started

Caution:

- **Do not install the unit where combustible gas may leak.**
 - If the gas leaks and accumulates around the unit, an explosion may result.
- **Do not use the air conditioner in special environments.**
 - Oil, steam, sulfuric smoke, etc. can significantly reduce the performance of the air conditioner or damage its parts.
- **When installing the unit in a hospital, communication station, or similar place, provide sufficient protection against noise.**
 - The inverter equipment, private power generator, high-frequency medical equipment, or radio communication equipment may cause the air conditioner to operate erroneously, or fail to operate. On the other hand, the air conditioner may affect such equipment by creating noise that disturbs medical treatment of image broadcasting.
- **Do not install the unit on a structure that may cause leakage.**
 - When the room humidity exceeds 80% or when the drain pipe is clogged, condensation may drip from the indoor unit. Perform collective drainage work together with the outdoor unit, as required.

Before getting installed (moved)-electrical work

Caution:

- **Ground the unit.**
 - Do not connect the ground wire to gas or water pipes, lightning rods, or telephone ground lines. Improper grounding may result in electric shock.
- **Install the power cable so that tension is not applied to the cable.**
 - Tension may cause the cable to break and generate heat and cause a fire.
- **Use power line cables of sufficient current carrying capacity and rating.**
 - Cables that are too small may leak, generate heat, and cause a fire.
- **Use only a circuit breaker and fuse of the specified capacity.**
 - A fuse or circuit breaker of a larger capacity or a steel or copper wire may result in a general unit failure or fire.
- **Do not wash the air conditioner units.**
 - Washing them may cause an electric shock.
- **Be careful that the installation base is not damaged by long use.**
 - If the damage is left uncorrected, the unit may fall and cause personal injury or property damage.
- **Install the drain piping according to this Installation Manual to ensure proper drainage. Wrap thermal insulation around the pipes to prevent condensation.**

- Improper drain piping may cause water leakage and damage to furniture and other possessions.
- **Be very careful about product transportation**
 - If the product weighs more than 20 kg [44 lb], then more than one person should carry the product.
 - Some products use PP bands for packaging. Do not use any PP bands for a means of transportation; it is dangerous.
 - Do not touch the heat exchanger fins. Doing so may cut your fingers.
- **Safely dispose of the packing materials.**
 - Packing materials, such as nails and other metal or wooden parts, may cause stabs or other injuries.
 - Tear apart and throw away plastic packaging bags so that children will not play with them. If children play with a plastic bag which was not torn apart, they face the risk of suffocation.

Before Starting the test run

Caution:

- **Turn on the power at least 12 hours before starting operation.**
 - Starting operation immediately after turning on the main power switch can result in severe damage to internal parts. Keep the power switch turned on during the operational season.
- **Do not touch the switches with wet fingers.**
 - Touching a switch with wet fingers can cause electric shock.
- **Do not touch the refrigerant pipes during and immediately after operation.**
 - During and immediately after operation, the refrigerant pipes may be hot or may be cold, depending on the condition of the refrigerant flowing through the refrigerant piping, compressor, and other refrigerant cycle parts. Your hands may suffer burns or frostbite if you touch the refrigerant pipes.
- **Do not operate the air conditioner with the panels and guards removed.**
 - Rotating, hot, or high-voltage parts can cause injuries.
- **Do not turn off the power immediately after stopping operation.**
 - Always wait at least five minutes before turning off the power. Otherwise, water leakage and trouble may occur.

SELECTING AN INSTALLATION SITE

- Avoid locations exposed to outside air.
 - Select a location free of obstructions to the airflow in and out of the unit.
 - Avoid locations exposed to steam or vapor
 - Avoid locations where combustible gas may leak, settle or be generated.
 - Avoid installation near machines emitting high-frequency waves (high frequency welders, etc.).
 - Avoid locations where the airflow is directed at a fire alarm sensor. (Hot air could trigger the alarm during operation)
 - Avoid places where acidic solutions are frequently used.
 - Avoid places where sulphur-based or other sprays are commonly used.
 - If the unit is run for long hours when the air surrounding the unit is a high temperature/high humidity (dew point above 80°F, dew condensation may be produced on the unit. When operating the units in this condition, add insulation material (13/32 – 13/16 in) to the entire surface of the unit to avoid condensation.
-

INSTALLING THE UNIT

The air handler can be installed in a vertical or horizontal (**left only**) configuration as shown below. The units are designed for "0" zero clearance to combustibles. 24" is required for service access to the front of the unit. (See below) Regardless of mounting configuration, the air handler must be mounted level to facilitate proper condensate drainage.

Installation Clearances

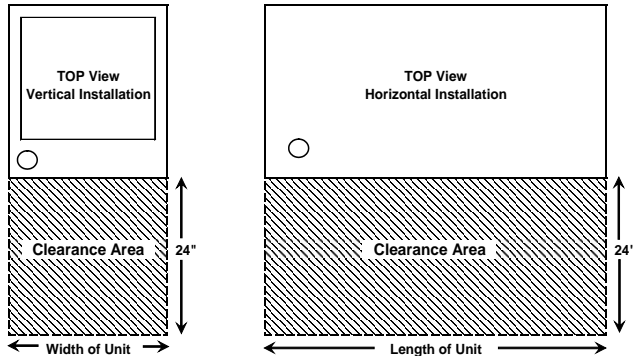

Vertical Applications: The air handler must be supported on the bottom only and set on a solid floor with a return plenum below or field supplied supporting frame or plenum. Securely attach the air handler to the floor or supporting frame or plenum.

Unit Mounted on Return Plenum

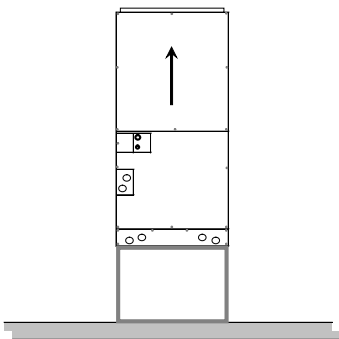

Horizontal (LEFT ONLY) Installations: No changes need to be made to the unit for horizontal installation. The unit can be installed on a platform or suspended from rails as shown below. The rails must run the length of the unit and be of sufficient strength to support the weight of the unit and connected ductwork. Vibration isolation is recommended for horizontal installations. Some jurisdictions may require an auxiliary drain pan to be mounted under the unit. Always follow local or national code requirements.

Platform Mounting

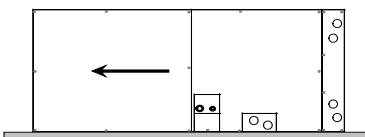

Suspended Mounting

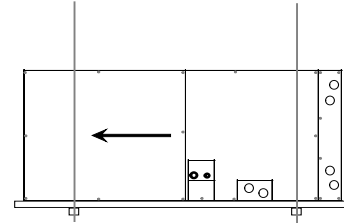

Air Filter

An air filter (provided by others) is to be installed on the return side of the air handler. The face area and pressure drop is to be determined by the installing contractor based on the overall static pressure performance of the system including supply and return ductwork sizing. The factory static pressure performance is .30" esp. A field selectable .50 esp. is available. See instructions for changing to .50 esp. in the electrical section.

REFRIGERANT PIPING

This piping work must be done in accordance with the installation manuals for both outdoor unit and BC controller (R2/WR2 series)

Series R2 is designed to operate in a system that the refrigerant pipe from an outdoor unit is received by the BC controller and branches at the BC controller to the indoor units.

For constraints on piping length and allowable difference of elevation, refer to the design section of the engineering manual.

The method of pipe connection on the air handler is braze connection.

Cautions of refrigerant piping

Be sure to use non-oxidative procedures for brazing to ensure that no foreign matter or moisture enters the piping.

ALWAYS USE A NITROGEN PURGE IN THE PIPING DURING BRAZING

Provide proper bracing for refrigerant piping so no load is imparted upon the connections at the air handler.

⚠ Warning:

When installing and moving the unit, do not charge it with refrigerant other than the refrigerant specified on the unit. Mixing of a different refrigerant, air, etc. may cause the refrigerant cycle to malfunction and result in severe damage.

⚠ Caution:

Use refrigerant piping made of C1220 (Cu-DHP) phosphorous deoxidized copper as specified in ASTM B280 Standard for copper and copper alloy seamless pipes and tubes. In addition, be sure that the inner and outer surfaces of the pipes are clean and free of hazardous sulphur, oxides, dust/dirt, shaving particles, oils, moisture, or any other contaminant. Never use existing refrigerant piping.

⚠ Caution: COIL UNDER PRESSURE

Always wear safety glasses when working around pressurized devices.

The air handlers are shipped with a nitrogen holding charge in the coil. Carefully follow these instructions when releasing the charge.

The suction line stub contains a schrader valve where the factory pre-charged the coil with nitrogen. This valve is located behind the panel where the suction line comes out. This can be accessed by removing the blower panel (top panel). (See drawing below)

Remove the cap and depress the schrader valve core to release all pressure within the coil. Replace the cap and finger tighten. Once all pressure is released the brazed ends of both tubes can now be removed with a tubing cutter. If necessary ream the connections to accept the refrigerant lines.

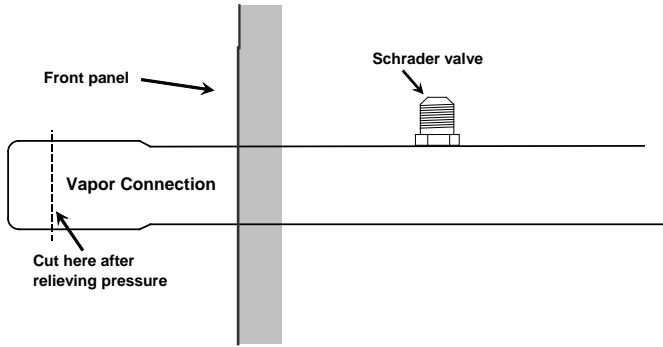

Always use proper refrigerant line sizes as shown:

Unit size

P12, P18	1/4" liquid x 1/2" gas
P24 – P54	3/8" liquid x 5/8" gas

Both refrigerant lines need to be insulated all the way up to the cabinet. Make sure the openings in the cabinet around the refrigerant lines are sealed. 3/8 in thick insulation is the minimum recommended thickness. Based on ambient conditions, local codes and line length, thicker insulation may be desired.

DRAIN CONNECTIONS

IMPORTANT!

Over-tightening the drain connections could result in drain pan breakage and failure.

The air handler contains three sets of 3/4" FPT drain connections. When the unit is used in the vertical position, there are a left-hand set and a right-hand set. When the unit is mounted horizontal (**left only**) there is one set. Each set contains a primary drain and a secondary or auxiliary drain. The primary drain is the one that is lowest (even with the bottom of the pan). The secondary drain is at the higher level.

These units operate with a negative pressure at the drain connections and require a drain trap be installed to prevent air from being drawn in and preventing positive drainage. The trap needs to be installed as close to the unit as possible. Make sure the top of the trap is below the connection to the drain pan to allow complete drainage of the pan.

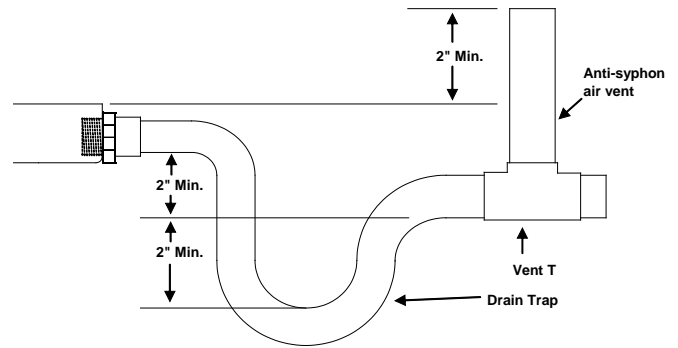

Note: Horizontal runs must also have an anti-siphon air vent (standpipe) install ahead of the horizontal run to eliminate air trapping. Horizontal drain lines must be pitched a minimum 1/8" per foot.

Route the drain lines outside or to an appropriate drain. Drain lines must be installed so they do not block service access to the front of the unit. 24" clearance in the front is for routine maintenance or service.

Note: Check local codes before connecting the drain line to an existing drainage system.

Insulate the drain lines where sweating could cause water damage. Upon completion of installation, it is the responsibility of the installer to ensure the drain pan(s) is capturing all condensate, and all condensate is draining properly and not getting into the ductwork/system.

Vertical Mounting:

When mounted vertically, the air handler has a choice of left or right hand drain connections. Select the drain connection set that is most convenient for routing piping. For left hand drains the connections are visible and ready for installation. Attach the drain connectors **finger tight** and install the drain line. For right hand remove the caps covering the drain pan openings. Remove the plugs and reinstall in the left hand drain opening. Install cover caps over these plugs. Now attach the drain connector **finger tight** and install the drain line.

IMPORTANT!

Over-tightening the drain connection could result in drain pan breakage and failure.

The secondary connection if used should be connected to a separate drainage system. Run the secondary drain so the occupants will be able to notice water flowing through the secondary drain indicating a blockage in the primary drain. Optional use for the secondary is a primary drain line overflow switch (provided by others). This device will shut the cooling operation unit down in the event of a primary drain line blockage. See wiring section for connecting this device.

Horizontal:

If the unit is installed horizontally, remove the plugs installed in the drain pan openings and attach connector **finger tight** and route drain line. Any vertical drain pan openings must be covered to eliminate air loss.

IMPORTANT!

Over-tightening the drain connection could result in drain pan breakage and failure.

The secondary connection if used should be connected to a separate drainage system. Run the secondary drain so the occupants will be able to notice water flowing through the secondary drain indicating a blockage in the primary drain. Optional use for the secondary is a primary drain line overflow switch (provided by others). This device will shut the cooling operation unit down in the event of a primary drain line blockage. See wiring section for connecting this device.

Electrical Box Component Location

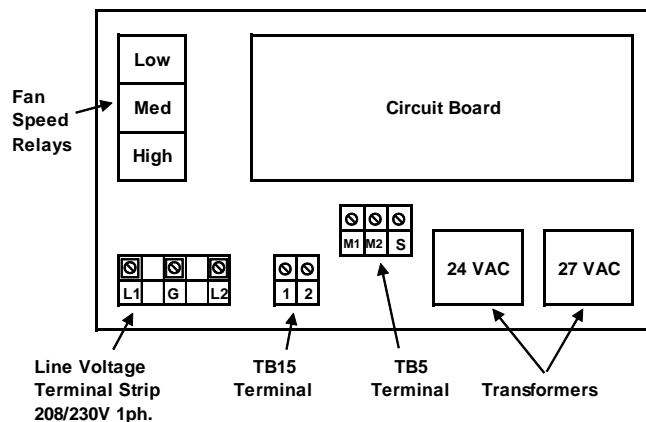

ELECTRICAL WIRING

⚠ Warning:

Electrical work should be done by a qualified electrical contractor in accordance with “Engineering Standards for Electrical Installation” and supplied installation manuals. If the power circuit lacks capacity or has an installation failure, it may cause a risk of electrical shock or fire.

- Be sure to follow local and national code requirements when wiring these units
- Install the unit to prevent that any of the control circuit cables (remote controller, transmission cables) is brought in direct contact with the power cable outside the unit.
- Ensure that there is no tension on any wire connections

⚠ Caution:

Be sure to ground the unit. Do not connect the grounding cable to any gas pipe, water pipe, lightning rod, or telephone earth cable. Incomplete grounding may cause a risk of electrical shock.

Types of control cables

Wiring transmission cables (M-NET)

Types of transmission cable: Shielded wire CVVS or CPEVS

Cable diameter: (AWG16)

Maximum wiring length: Within 200 m (656ft.)

Maximum length of transmission lines for centralized control and indoor/outdoor lines (Maximum length via indoor units): 500 m [1640ft] MAX

The maximum length of the wiring between power supply (PAC-SC51KUA) for transmission lines (on the transmission lines for centralized control) and each outdoor unit and system controller is 200 m (656ft)

Controllers

M-NET (ME) Controllers

Type of transmission cable: Sheathed 2-core cable (unshielded)

Cable diameter: (AWG18)

Note: When 10 m (33 ft) is exceeded use same cable as specified for transmission wiring above.

MA Controllers – Minimum 18 gauge

Type of transmission cable: Sheathed 2-core cable (unshielded)

Cable diameter: (AWG18)

Note: Length not to exceed 200 m (265')

Wire size for Main Power Supply and On/Off Capacities.

Minimum Wire size AWG

Main Cable:	14
Branch:	14
Ground:	14

Breaker for Wiring (NFB)

15 A

⚠ Caution:

Do not use anything other than the correct capacity breaker and fuse. Using fuse, wire or copper wire with too large capacity may cause a risk of malfunction or fire.

Connecting remote controller, indoor and outdoor transmission cables

Connect indoor unit TB5 and outdoor unit TB3. (Non-polarized 2-wire)

The “S” on indoor unit TB5 is a shielding wire connection. For specifications about the connecting cables, refer to the outdoor unit installation manual.

Install a remote controller following the manual supplied with the remote controller.

Connect the “1” and “2” on the indoor unit TB15 to a MA remote controller. (Non-polarized 2-wire)

Connect the “M1” and “M2” on indoor unit TB5 to an M-NET remote controller. (Non-polarized 2-wire)

Typical transmission wire connections when using MA remote controllers

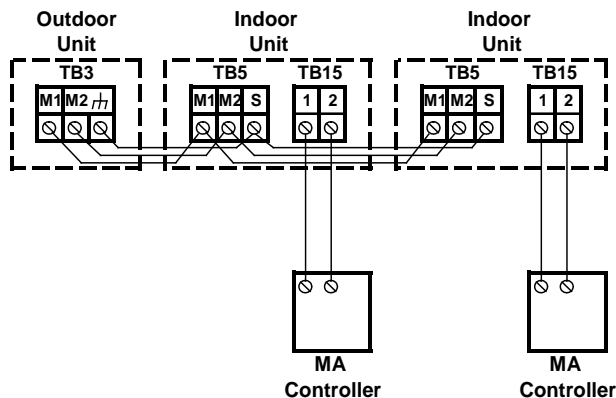

The MA remote controller and the M-NET remote controller cannot be used at the same time or interchangeably.

Typical transmission wire connections when using ME remote controllers

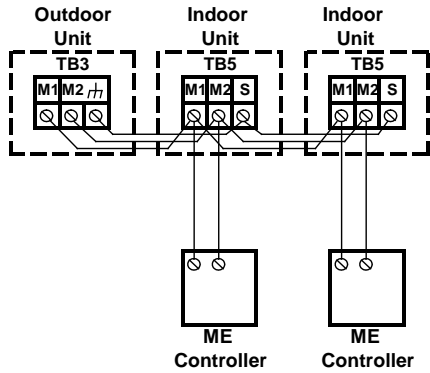

Note:

Ensure that the wiring is not pinched when fitting the terminal box cover. Pinching the wiring may cut it.

Caution:

Install wiring so that it is not tight and under tension. Wiring under tension may break or overheat and burn. Fix power source wiring to control box by using buffer bushing or tensile force. (PG connection or the like) Connect transmission wiring to transmission terminal block through the knockout hole of control box using ordinary bushing.

After wiring is complete, make sure again that there is no tension on the connections, and attach the cover onto the control box in the reverse order removal.

Caution:

Wire the power supply so that no tension is imparted. Otherwise disconnection, heating or fire may result.

Important:

Attach shielding ground on the outdoor unit's ground terminal.

If the remote controller cable exceeds 10 m [32 ft], use a 1.25 mm² [AWG16] diameter cable over the exceeded portion, and add that exceeded position to within 200 m [656 ft].

The BC controller is required only for simultaneous cooling and heating series R2.

Connecting Line Voltage

Make sure power supply is off.

On the line voltage terminal block loosen the screws marked L1, L2 and G on the line voltage terminal strip. Insert line voltage wires and tighten screws.



Caution:

Wire the power supply so that no tension is imparted. Otherwise disconnection, heating, or fire may result.

208 Volt Power Supply

The air handler comes from the factory with the 24VAC transformer wired for a 230 volt supply voltage. For 208 volt power supply the line voltage lead needs to be changed. Remove the wire nut covering the orange wire. Disconnect the white wire from the white lead going to the line voltage terminal strip. Connect the orange lead to the white wire going to the line voltage terminal strip using the wire nut. Now cover the white lead with the remaining wire nut (see below)

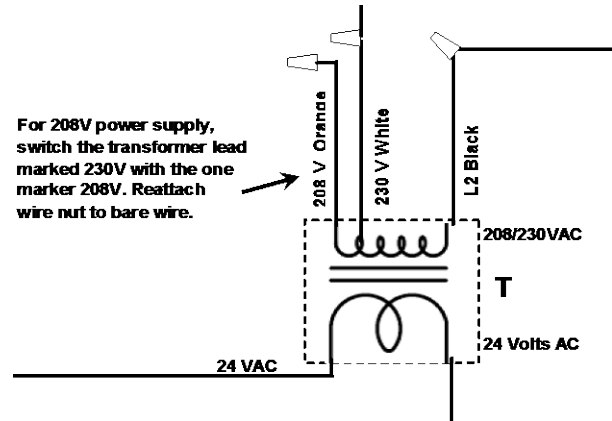

Setting addresses

(Be sure to operate with the main power turned OFF.)

<Address board>

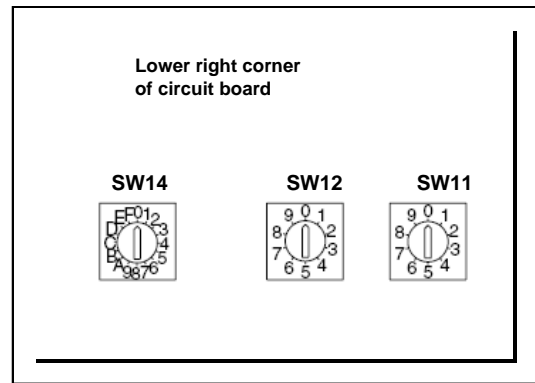

There are two types of rotary switch setting available: setting addresses 1 to 9 and over 10, and setting branch numbers. How to set addresses:

Example: If Address is "3", leave SW12 (for over 10) at "0", and match SW11 (for 1 to 9) with "3"

How to set branch numbers SW14 (Series R2 only):

Match the indoor unit's refrigerant pipe with the BC controller's end connection number. If there is no BC controller used leave at "0".

The rotary switches are all set to "0" when shipped from the factory. These switches can be used to set unit addresses and branch numbers at will.

The determination of indoor unit addresses varies with the system at site. Set them referring to technical data.

Sensing room temperature with the built-in sensor in a remote controller

If you want to sense room temperature with the built-in sensor in a remote controller, set SW1-1 on the control board to "ON". The setting of SW1-7 and SW1-8 as necessary also makes it possible to adjust the air flow at a time when the heating thermometer is off.

Condensate overflow safety switch connection (CN31)

The circuit board is equipped with a connection to attach a condensate safety float switch. The switch should be a normally closed low voltage rated switch. The switch should be installed in a location that it can sense a drain blockage causing a rise in water level. This resulting rise in level will cause it to open. The switch location is to be determined by the installing contractor. When the switch opens, it will cause the LEV to close, stopping the cooling operation. The fan will continue to run and a fault code will be shown at the controller. Correcting the problem and closing the switch will be required before normal operation can resume. See installation below:

Locate the CN31 connector in the upper right-hand corner of the circuit board. Carefully remove the connector with the jumper from the board. Cut the jumper on the CN31 connector and wire a normally closed safety float switch across these wires. Carefully reinstall the connector back onto the board

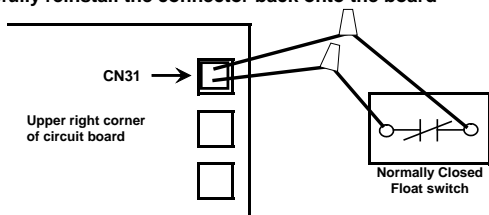

Changing Blower Static Pressure

The air handler is equipped with an adjustable static pressure setting. The available settings are shown in the table below.

Model	Available Ext. Static (In. W.G.)		
PVfy-P12	0.20	0.40 *	0.60
PVfy-P18	0.30	0.50 *	0.80
PVfy-P24	0.30	0.50 *	0.80
PVfy-P30	0.30	0.50 *	0.80
PVfy-P36	0.30	0.50 *	0.80
PVfy-P48	0.30	0.50 *	0.80
PVfy-P54	0.30	0.50 *	0.80

* Factory Setting

The blower static pressure setting can be changed by moving the green, blue and red wires on the motor according to the following wiring diagram.

Use pliers to grasp and remove the connectors. Failure to do so could result in the wire pulling free from the spade connectors.

